

762C Series SINGLE STATION MICRO[®] Controller



The 762C Series Controller is a multi-purpose station with the ability to accomplish one or two independent control strategies concurrently. It can also be configured as one or two 3-variable indicator stations and one or two auto/manual transfer stations. Control, indicator, and auto/manual functions are intermixable. As symbolized by the "CE" marking, these controllers conform to the European Union directives.

INTRODUCTION

The 762C is a microprocessor-based controller that performs the standard proportional, integral, and derivative (PID) control functions for up to two independent loops. Additionally, it provides many enhanced functions including Foxboro's patented EXACT tuning algorithm, user-configurable control functions, auto selector control, split range outputs, auto/manual transfer stations, assignable 3-variable indicator functions, totalization, a comprehensive calculation capability, and signal conditioning. Standard controller signals include:

four analog inputs, two frequency inputs, two contact inputs, an optional platinum RTD direct input, two analog outputs, and two contact outputs.

A fluorescent display is used to show the control variables in bargraph format, and to provide precision digital readout. It also displays an electronic loop tag, controller status, and alarm indication. A keypad, located on the front of the controller, is used for operator interface and configuration.

The controller is available for mounting directly in a panel or in Foxboro shelves.



FEATURES

- Two Independent PID Controllers
- Single Station Cascade Control
- Single Station Auto Selector Control
- Split Range Outputs
- Ratio Control
- Batch (Discontinuous) Control
- Totalization
- 3-Variable Indicators
- Auto/Manual Transfer Stations
- Assignable Alarms
- Algebraic Computation
- Dynamic Compensation with Lead/Lag, Impulse, and Dead Time Functions
- Boolean Logic Capability
- EXACT Control (Foxboro U.S. Patent RE 33267)
- Flexible Configuration Blocks with Internal Signal Routing
- Fully Interactive Display
- Configuration and Display of an Independent Variable
- Pulse Driven Input
- RS-485 Serial Communications for Operation and Configuration
- Nonvolatile Memory
- Transportable Configuration
- Power Failure Recovery Logic
- Front Panel Keypad for Both Configuration and Operator Interface
- Internal Signal Sources for Calibration
- Integral Field Power Supply
- Passcode Security
- DIN or Shelf Mounting

TWO INDEPENDENT CONTROLLERS

Two completely independent control strategies can be used. All control support functions are available for both controllers, thereby allowing high-performance, enhanced control of each loop.

CASCADE CONTROL

With this controller configuration, the output of one of the controllers (primary controller) drives the set point of the other (secondary) controller. This configuration can improve the performance of certain control loops where load disturbances are a factor.

AUTO SELECTOR CONTROL

Two controllers with a single selected output are combined in this configuration to provide constraint

control or dual mode control. The choice of lower, higher, or logic-selected output is configurable. The inherent design prevents controller windup and offers independent or interlocked auto/manual functions.

SPLIT RANGE OUTPUTS

The two 4-20 mA outputs can be driven from a single controller. This allows one measured variable to be controlled by two manipulated variables. A typical application is a temperature control system in which both the heating medium and the cooling medium are manipulated.

ACTUAL OUTPUT INDICATION

The output bargraph and digital indicator can be configured to display the actual 4-20 mA output value, or any analog signal, such as valve position feedback.

TOTALIZERS

Up to two 7-digit totalizers are available. The totalizers can be set to integrate *up to* a preset value or *down from* a preset value, and produce a logic event output. Any internal or external signal can be totalized.

Totalization and EXACT tuning are mutually exclusive. For example, if one controller is configured for EXACT tuning, only one totalizer is available.

EXACT CONTROL

EXACT control uses microprocessor technology to make ongoing controller adjustments based on the actual, real time process dynamics. This is in direct contrast to other "self-tuning" controllers that establish the values of tuning parameters based on an arbitrary process model.

While continuously scanning the process variables, EXACT control initiates corrective action upon sensing a process upset. The user selects the desired response by specifying the desired damping and overshoot-to-load change, such as quarter amplitude damping.

Values of EXACT can be read by the user.

EXACT control functions as if your best operator is on the job 24 hours a day. It can be turned on or off at the keypad or by configuring logic functions, allowing these controllers to function as advanced PID controllers.

EXACT control is available on both control loops.

3-VARIABLE INDICATOR

Up to two 3-variable indicator faceplates are available. Each variable has its own bargraph, digital engineering units, and loop tag. The 3-variable faceplates are mutually exclusive with controllers and auto/manual stations. If only one controller or manual station is configured, one 3-variable faceplate will be available.

AUTO/MANUAL TRANSFER STATION

Up to two auto/manual stations are available. Auto/manual stations are mutually exclusive with controllers and indicators. For example, if only one controller or indicator is configured, one auto/manual station will be available.

PULSE DRIVEN INPUT

There is provision for two pulse inputs, forming a pulse up/pulse down pair that can be assigned to any scaled signal such as remote set point. This function is compatible with the signals used for older stepping motor type devices.

RS-485 SERIAL COMMUNICATIONS INTERFACE

This controller is equipped with an RS-485 serial port for communication with most host computers, either directly or via an RS-232/RS-485 converter or equivalent accessory. Protocol conforms to ANSI Specification X3.28-1976, Subcategory E3. Using the Foxboro Model F6501A Converter, up to 90 controllers can be accommodated with a single host communication port.

Serial communications capability includes uploading/downloading of configuration, setting of Auto/Manual (A/M) or Remote/Local (R/L) status and manual output and local setpoint values, polling of all inputs, outputs, and totalizers, and writing as well as reading of all configurable parameters. Both control loops are accommodated. The user can also select parity and panel, workstation (host), or "both" priority. Communications rate is configurable for 2400, 4800, 9600, or 19,200 baud.

COMPUTATIONAL CAPABILITY

This controller performs up to three independent calculations. The variables may include the results of other calculation blocks, scaled and conditioned inputs, and other internal control signals.

An equation is entered from the keypad one character at a time following the usual rules of algebra and a few easy-to-learn rules. The result of this flexibility is exceptional computational capability in a single station controller.

SIMPLIFIED CONFIGURATION AND OPERATION

Because of its flexibility, this controller is easily configured to meet the most exacting process requirements. All operating functions are examined and/or changed by keystrokes. Interactive prompting simplifies setting the adjustable parameters.

COMPLETE SECURITY

The operator has keypad access to read the values of inputs, alarm and limit settings, and the operating configuration. However, the operator can adjust only those settings which were specified as operator-adjustable when the controller was configured. A passcode must be entered from the keypad to enable adjustment of the remaining parameters.

This passcode is determined by an authorized person at the time the controller is configured. Thus, only those who have been given this passcode can change any of the protected parameters.

BOOLEAN LOGIC CAPABILITY

There are five single gates and five dual gates. Each gate is configured by selecting the logic and then selecting the source of each input. Gates 0 through 4 are the single input gates and are configured DIRECT or NOT by the user. Gates 5 through 9 are the dual input gates and the user selects one of the following logic types for each one: OR, NOR, AND, NAND, XOR, or XNOR.

DYNAMIC COMPENSATION

The result of a dedicated calculation block can be passed through a dynamic compensator, prior to distribution. The dynamic compensator provides lead/lag, impulse, and dead time functions, each with its individual follow (bypass) switch. Functionally, dead time precedes lead/lag and is the input to the lead/lag function.

Utilizing the dynamic compensator and the follow switches, feedforward and other complex control applications are easily and efficiently handled.

FRONT PANEL

The controller can be configured and operated entirely from the front panel without need for any external equipment. The panel consists of an alphanumeric display, a graphics display, status indicators, an alarm indicator (horn symbol), and a keypad. Refer to Figure 1.

The alphanumeric display at the top of the front panel has two lines of nine characters each. The characters are 5 mm (0.196 in) high, and colored Blue-Green.

The graphics display consists of three bargraphs, each having 50 segments plus a pointer on top and bottom. The bars are 55.4 mm (2.18 in) long. The left

and center bargraphs are 5 mm (0.196 in) wide, and the right bar graph is narrower at 2.5 mm (0.098 in). The bargraphs are colored Blue-Green.

The status characters (W/P, R/L, A/M) are 4 mm (0.157 in) high; the alarm symbol is 5 mm (0.196 in) high. The status characters are colored Blue-Green; the alarm symbol is Red.

The keypad has eight keys as shown in Figure 1 and identified in Table 1 on page 5. The key switches are single pole, normally open contacts, all closing to a common lead.

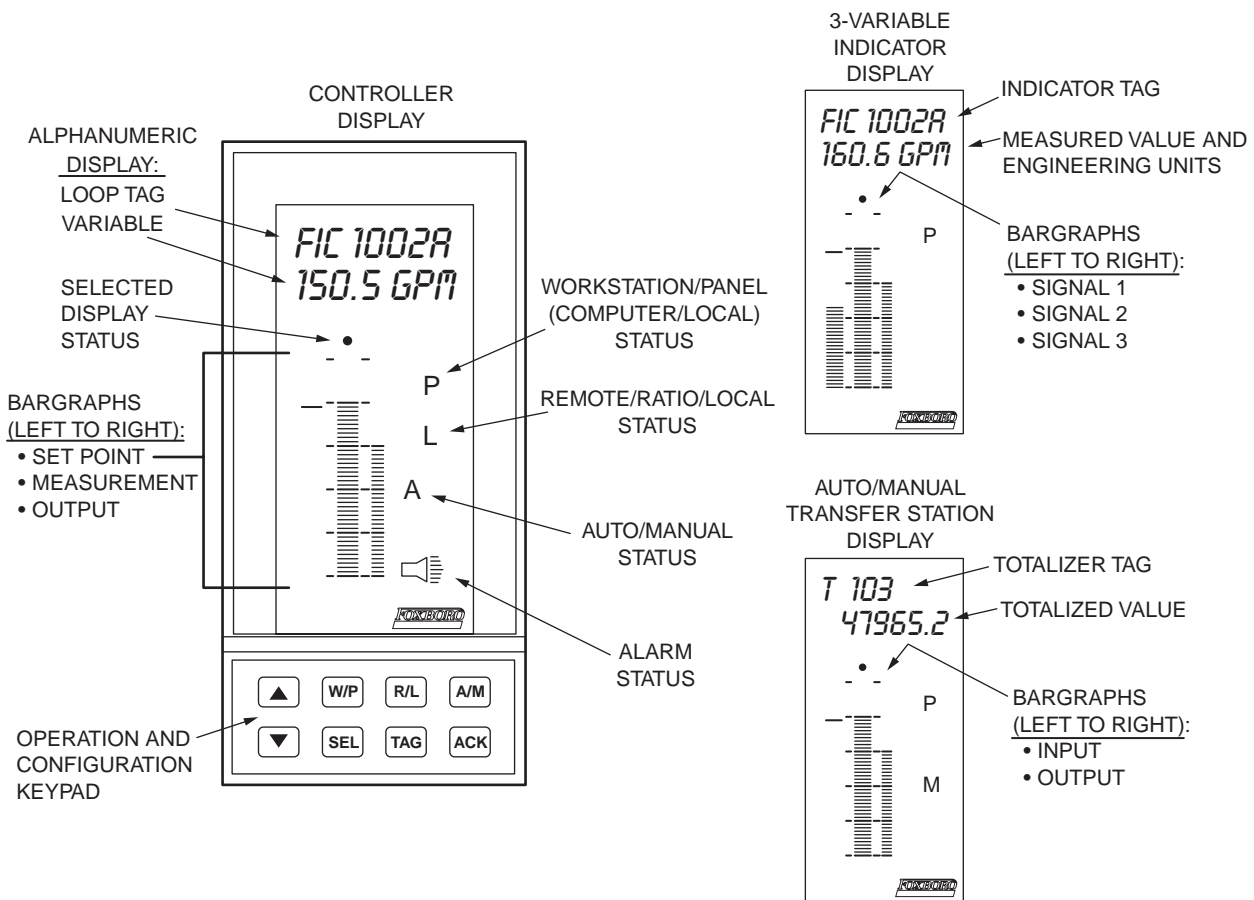









Figure 1. Controller Front Panel

COPY MEMORY FEATURE

This optional copy memory feature permits the configuration of one controller to be duplicated for use in another controller. This is accomplished using two NOVRAMs (nonvolatile, random access memory modules) and a configuration copy accessory. Briefly, after turning off the power, the procedure is as follows: remove the configured NOVRAM from the controller; install the copy accessory; plug the

configured NOVRAM and a second NOVRAM (to be configured) into the copy accessory; then turn on the power and the second NOVRAM is copied for use in another controller. With minimum effort, any number of controllers can thus be configured with the same parameter values as the original controller. Then individual parameters in each controller are easily changed to fit the particular loop.

Table 1. Keypad Description

Key Name	Usage of Key
	Depression when the Controller is in the PANEL (P) mode, causes the Controller to exit from the operator FACEPLATE and enter the READ or SET menu. When the Controller is in the WORKSTATION (W) mode, the TAG is disabled.
	In FACEPLATE mode, if an alarm has not been acknowledged, depression of the ACK key will remove the alarm from the Alarm indicator flashing queue and put alarm into the Alarm indicator steady queue. In READ or SET mode, depression of this key accepts an entry, stores a variable, and/or steps forward to the next function. ACK is functional whether in W or P mode.
	In FACEPLATE mode: Short Depression (0.1 to < 0.3 s): Moves through variables being displayed on bargraphs, displaying each, in turn, on lower alphanumeric display. Also provides access to remote set point, ratio, and totalized count, provided these have been configured. Long Depression (0.3 s): Toggles between faceplates of the two controllers, indicators, and auto/manual stations, provided they are configured and active. Otherwise, same action as if it were a Short Depression. In READ or SET mode, depression steps backward to the previous function. The SEL key is independent of whether Controller is in W or P mode.
	Controller Status Switch; toggles between Workstation (W) and Panel (P) operation. This key is functional only when Workstation/Panel is configured and the W/P switch is configured to NONE. It is non-functional when the controller is configured for "W" priority.
	Controller Status Switch; toggles between Auto (A) and Manual (M) operation. This key is functional only when the A/M switch is configured to "NONE". It is non-functional when Controller is in "W" mode. The bargraph pointer indicator will automatically preselect the Output Bargraph when transferring to "M", and the Measurement Bargraph when transferring to "A".
	Controller Status Switch; toggles between Remote or Ratio (R) and Local (L) setpoint operation. This key is functional only when remote set point is configured and R/L switch is configured to "NONE". The key is non-functional when Controller is in "W" mode.
 	Up and Down arrows are bidirectional movement requestors. They are used to select menu items and functions, reconfigure parameters, and make changes to the set point and the manual output value.

OPERATING AND STORAGE CONDITIONS

Influence	Reference Operating Conditions	Normal Operating Condition Limits	Operative Limits	Transportation and Storage Limits
Ambient Temperature	23 ±2°C (73 ±3°F)	-10 and +60°C (14 and 140°F)	-10 and +60°C (14 and 140°F)	-40 and +70°C (-40 and +160°F)
Relative Humidity	50 ±10%	5 and 95% (noncondensing)	5 and 95% (noncondensing)	0 and 100% (noncondensing)
Supply Voltage	24, 100, 120, 220 and 240 V ac, ±1% 24 V dc, ±1%	V ac, +10, -15% V dc, +10, -15%	V ac, +15, -20% V dc, +10, -15%	— —
Supply Frequency	50/60 Hz, ±0.1 Hz	50/60 Hz, ±3 Hz	40 and 65 Hz	—
Vibration	Negligible	5 and 200 Hz at an acceleration of 2.5 m/s ²	—	10 m/s ² (1 "g") for 1 hour when in shipping container
Mechanical Shock	Negligible	—	—	A 42 inch drop when in shipping container.

PERFORMANCE SPECIFICATIONS

Accuracy at Numeric Display

See the table below.

Numeric Display Accuracy Table

Parameter	Accuracy
Set Point	±0.1% of span
Input Analog RTD (Direct Meas.)	±0.1% of span ±0.5°C
Output	±0.5% of span
Linearization RTD Thermocouple	±0.5°C, reading only ±0.5°C, reading only

Resolution

DISPLAY

±0.1% of upper range value

BARGRAPH

±2% of upper range value

Frequency Response

Analog input to output conversion is flat to 3 Hz.

Supply Voltage Effect

±0.1% of span (maximum) for a +10% or -15% change in ac or dc voltage within normal operating conditions.

Output Noise

0.25% maximum, peak-to-peak.

Humidity Effect

Maximum error in any conversion, calculation, or setting is ±0.1% of span for a change from reference conditions to 95% R.H. at 30°C (85°F) wet bulb.

Ambient Temperature Effect

Maximum error in percent of span, except as noted, for a 30°C (55°F) change in temperature within normal operating limits. See table below.

Parameter	Maximum Error
Set Point Local Remote	less than 0.1% less than 0.5%
Input Analog Frequency RTD	less than 0.5% less than 0.25% less than 0.5°C
Outputs	less than 0.5%

FUNCTIONAL SPECIFICATIONS

Proportional Input Signals

Any combination of the following proportional inputs; not to exceed four analog (4-20 mA, 1-5 V, TC, or RTD) and two frequency inputs. All input signals are converted ten times per second and can be characterized or combined in a variety of calculations. See table below.

Proportional Type Input Signal	Maximum Number	Details									
4 to 20 mA dc Current Input	4	4 to 20 mA dc input is standard. Inputs are across 250 Ω resistors located inside housing.									
1 to 5 V dc Voltage Input	4	Controllers will accept 1 to 5 V dc by removing the input resistor(s) used with the current input.									
Thermocouple Input (requires 893 Temperature Transmitter, or equivalent)	4	Linearization of displayed value is provided, as follows: <table border="0"> <tr> <td>Thermocouple</td> <td>Temperature Range</td> </tr> <tr> <td>Type J</td> <td>-20 to +760°C (-4 to +1400°F)</td> </tr> <tr> <td>Type K</td> <td>-20 to +1380°C (-4 to +2500°F)</td> </tr> <tr> <td>Type E</td> <td>-130 to +540°C (-200 to +1000°F)</td> </tr> </table>	Thermocouple	Temperature Range	Type J	-20 to +760°C (-4 to +1400°F)	Type K	-20 to +1380°C (-4 to +2500°F)	Type E	-130 to +540°C (-200 to +1000°F)	
Thermocouple	Temperature Range										
Type J	-20 to +760°C (-4 to +1400°F)										
Type K	-20 to +1380°C (-4 to +2500°F)										
Type E	-130 to +540°C (-200 to +1000°F)										
1 to 9999 Hz Frequency Input	2	Input pulse rates, voltage levels, and field power are compatible with Foxboro E83 Series Vortex Flowmeter, and with Foxboro 81 and 82 Series Turbine Flowmeter having a preamplifier input. Input impedance is 250 Ω.									
1 to 9999 Hz Pulse Up/ Pulse Down Inputs (Uses both Frequency Inputs.)	1 Pair	1 to 9999 Hz pulse up/pulse down pair of inputs driven by external contact closure or voltage pulse. Contact closure/open times and pulse voltage level are compatible with older stepping motor devices.									
Resistance Temperature Detector (RTD) Input, Direct or Temperature Difference Measurement. See Model Code section to select this optional RTD input.	1	Platinum, per IEC 100 or SAMA* 100 (RC 21-4) temperature curves. Linearization of displayed value is provided, as follows: <table border="0"> <tr> <td></td> <td>IEC 100</td> <td>SAMA 100</td> </tr> <tr> <td>Range</td> <td>-200 to +850°C (-330 to +1560°F)</td> <td>-200 to +600°C (-330 to +1100°F)</td> </tr> <tr> <td>Span</td> <td>110 to 1000°C (198 to 1800°F)</td> <td>110 to 800°C (198 to 1440°F)</td> </tr> </table>		IEC 100	SAMA 100	Range	-200 to +850°C (-330 to +1560°F)	-200 to +600°C (-330 to +1100°F)	Span	110 to 1000°C (198 to 1800°F)	110 to 800°C (198 to 1440°F)
	IEC 100	SAMA 100									
Range	-200 to +850°C (-330 to +1560°F)	-200 to +600°C (-330 to +1100°F)									
Span	110 to 1000°C (198 to 1800°F)	110 to 800°C (198 to 1440°F)									

*Scientific Apparatus Makers Association.

Two Discrete Inputs

Two nonisolated contact or transistor switch inputs, 5 V dc nominal open circuit voltage, 1 mA maximum current. For remote status changes such as A/M, R/L, W/P, EXT ACK, and tracking functions.

Control Functions

Within this station are two independent controllers with individual built-in options that can be configured. This station is also user-configurable to function as a single controller, cascade controllers, or an auto selector.

For each controller, the standard algorithms are P, I, PD, PI, PID, and EXACT control. The following options may be configured: nonlinear extender, ratio, measurement and set point tracking, output tracking, remote/local set point, output multiplication or summing, external reset, external limits for output, and simple batch control.

Output Signals

TWO NONISOLATED ANALOG OUTPUTS

- Output One: 4 to 20 mA nominal into 500 Ω maximum; isolation provided as an option.
- Output Two: 4 to 20 mA nominal into 500 Ω maximum, or 1 to 5 V dc nominal into 2 kΩ minimum, jumper selectable. Can be assigned by user for control, measurement, set point, or conditioned input signals.

TWO DISCRETE OUTPUTS

Two nonisolated open collector transistor (NPN) switch outputs. For status indication of A/M, R/L, W/P, and alarms, or can be configured as the destination for any two of the Boolean Gate Inputs. Contact ratings are 50 V dc maximum, 250 mA maximum. Leakage current is 100 μA maximum.

Other Control Functions

- Input bias, gain, and output bias available for every input.
- Characterizers (two available, 8 segments each, assignable).
- Boolean Gate Logic {DIRECT and NOT (single input); OR, NOR, AND, NAND, XOR, and XNOR (dual input); 18 function switches. Inputs selectable from contact inputs, alarm output states, status indicator outputs, EXACT state, gate outputs, and three fixed states}.
- Signal Conditioning (square, square root, characterizer).
- Split range outputs (configurable for both 4-20 mA outputs).

Alarms

Four dual-level alarms, each with a dead band and one Boolean output are available. Each alarm is configurable for Absolute, Deviation, Rate-of-Change, High/Low, High/High, Low/Low, Latching, Nonlatching, or Permissive. Each alarm can be configured to act on any one of a number of user-selected points.

- Can be configured to indicate alarm status by a combination of alphanumeric display, the bar graphs, an alarm symbol, and the contact outputs.
- The alarm dead band is adjustable between 0 and 100% of span.

Calculations

There are three calculation functions, designated CALC 1, CALC 2, and CALC 3. The variables in each calculation can be any combination of direct inputs to the controller, configured constants, and results of other calculation blocks. The available operators are +, -, /, *, >, <, $\sqrt{\quad}$ and ten Boolean gates. Open and close brackets are also available for grouping variables.

Transmitter Power Supply

Nominal 28 V dc power supply with a 250 Ω limiting resistor at each transmitter connection. Provides field power for two 4 to 20 mA transmitters with a maximum series resistance of 350 Ω in each current loop, including the 250 Ω input resistor.

Execution Rate

Ten times per second.

Toggle Mode

Configuring the TOGGLE mode allows a user to toggle (switch) between a menu level and the normal front panel display with a single keystroke.

Dynamic Compensation

The result of CALC 3 may be passed through the dynamic compensator function prior to distribution. This block provides lead/lag, impulse, and dead time functions, each with its individual follow switch. Functionally, dead time precedes lead/lag and is the input to the lead/lag function.

Dead time allows the input to CALC 3 to be delayed by a configured time before making it available to the output of CALC 3. The lead/lag function allows the output to dynamically lead or lag the input by a configured time. Both functions can be enabled or by-passed selectively utilizing the follow switches.

The impulse can be positive, negative, or bipolar and is part of the lead/lag function.

Dynamic Compensation Adjustment Limits

DEAD TIME

0 and 200 minutes

LEAD/LAG TIME

0 and 200 minutes

Memory

All configuration and operating parameters (not status data) are stored in a nonvolatile RAM device having a ten year data retention capability. Should a power failure occur, essential control settings and last operating conditions are saved indefinitely. No batteries are used.

Input Filter

Second order Butterworth filter. Adjustable from 0 to 10 minutes in 0.01 minute intervals.

Signal Distribution

Over thirty signals are available for internal routing. These are the conditioned and scaled inputs, unconditioned inputs, control inputs and outputs, and calculation results.

Power Consumption

15 VA maximum with 4 to 20 mA output

PHYSICAL SPECIFICATIONS

Display

Vacuum fluorescent lamps in glass enclosure having a glass frit seal and tin plated copper pin outs. Horn symbol (for alarms) is Red, and bargraphs and alphanumeric characters are Blue/Green.

Signal Connections (on rear panel)

762CNA

Two 16-position terminal blocks, with compression terminals, for wire sizes up to 3.3 mm² (12 AWG).

762CSA

Selectable by Model Code:

- 30-pin socket for use in 202S Shelf with 32-position terminal block and cord set. Terminal block has compression terminals for wire sizes up to 2.5 mm² (14 AWG).
- 20-pin socket for retrofit use in all Foxboro shelves using a 20-position terminal block and cord set. Some controller features cannot be used with this selection; refer to the Model Code for details.

Power Connections (on rear panel)

762CNA

3-position terminal strip with 8-32 screw connections.

762CSA

3-position power cord connector

Electronic Packaging

The electronic circuitry is mounted on two 1.6 mm (0.62 in) thick, glass-based epoxy, wiring boards. These electronic printed wiring assemblies (PWAs) are interconnected using 20-pin connectors.

Mounting

762CNA

Direct panel mounting. Refer to Dimensions-Nominal section.

762CSA

Mounts in a 202S Shelf or, for retrofit installations, in EH, 101, or 102 Series Shelves.

Approximate Mass

2.8 kg (6.2 lb)

ELECTRICAL SAFETY SPECIFICATIONS

Testing Laboratory, Types of Protection, and Area Classification	Application Conditions	Electrical Safety Design Code
CSA for Ordinary Locations.	—	CS-E/CG-A
CSA for Class I, Division 2, Groups A, B, C, and D.	Temperature Code T4.	CS-E/CN-A
FM for Ordinary Locations.	—	CS-E/FG-A
FM for Class I, Division 2, Groups A, B, C, and D.	Temperature Code T4.	CS-E/FN-A

NOTE

These controllers have been designed to meet the electrical safety descriptions listed in the table above. For detailed information, or status of the testing laboratory approvals/certifications, contact Foxboro.

OPTIONAL FEATURES AND ACCESSORIES

Output Isolation

This option provides an isolated 4 to 20 mA nominal signal (500 Ω load maximum) on output number 1. Select Model Code Optional Suffix “-1”.

Platinum RTD Input

This option provides for accepting a platinum RTD on input number 1. Calibrated per IEC 100 or SAMA 100 temperature curves. Each curve is linearized for digital readout over the ranges and spans listed below:

IEC 100 (Direct or ΔT Measurement)

Range: -200 to +805°C (-330 to +1560°F)
Span: 110 to 1000°C (198 to 1800°F)

SAMA 100 (Direct or ΔT Measurement)

Range: -200 to +600°C (-330 to +1100°F)
Span: 110 to 800°C (198 to 1440°F)
Specify by selecting Model Code Optional Suffix “-2”.

Factory Pre-Configuration

Unless otherwise specified, the controller is shipped with a Factory Default configuration consisting of a single measurement input, a local set point, PID EXACT control with EXACT turned off, and scale ranges of 0 to 100 percent.

Optional Factory Configurations are shown in Table 2. Because the controller is so powerful and virtually offers an unlimited number of solutions, only some of the more common basic applications are listed. Select the configuration that most closely meets your needs. Any changes necessary to meet your specific needs can easily be made in the field. It usually will be necessary to change, at minimum, the loop tag, the scale ranges, and the PID controller turning parameters to suit process requirements.

Optional factory pre-configuration is offered without additional charge. To order, refer to Table 2 and specify the Auxiliary Specification (AS) for the configuration that most nearly meets your needs. The AS will be displayed in the loop tag to assist in initial field identification.

Configuration Copy Accessory

All of the operating configuration is stored in a NOVRAM. The copy accessory permits the entire contents of the memory module to be quickly copied to another NOVRAM, either a spare or one from another controller. Specify Part Number L0122TU for the copy accessory, and Part Number K0141LN for a spare NOVRAM.

Surge Suppressor

A surge suppressor is optionally available for use with serial communication input when external wiring is located near transient producing sources such as meters, solenoids, high voltages, etc. Specify Auxiliary Specification (AS) SURSUP.

Replacement Shelf Signal Connector Assembly

This assembly is used for installing shelf-mounted controllers with 30-pin signal connector into existing 102, 202, and EH Series Shelves. The assembly includes plug, cable, and terminal block. Specify Part Number K0143CG for 4 to 20 mA inputs and outputs; or Part Number K0143EF for 10 to 50 mA inputs.

When ordering this accessory, a replacement power cord is also required (see Replacement Power Cord section). Three types are available. Specify Part Number listed in the following table.

Power Cord Type	Approximate Length	Part Number
Plug Type (Plug at each end)	1.2 m (4 ft)	N0139CA
Long Extension Type (Plug on one end)	5.6 m (18.5 ft)	N0139CB
Short Extension Type (Plug on one end)	1.2 m (4 ft)	N0139TZ

Guide for EH Shelves

A guide must be added between instruments when installing 762CSA Controllers in EH Shelves. Specify Part Number K0143CF.

Table 2. Factory Pre-Configuration Options

Description	AS ^(a) Reference
Single Loop Controller with Hi/Lo Measurement Alarm with one Totalizer with Hi/Lo Alarm and Totalizer with Split Range Outputs with 3-Variable Indicator Station with Auto/Manual Transfer Station	SINGL C SINGL C1 SINGL C2 SINGL C3 SINGL C4 SINGL C5 SINGL C6
Dual Loop Controller with Hi/Low Measurement Alarms with two Totalizers with Alarms and Totalizers	DUAL C DUAL C1 DUAL C2 DUAL C3
3-Variable Indicator Station with three Hi/Lo Alarms with two Totalizers with Alarms and Totalizers with second 3-Variable Indicator Station with second 3-Variable Indicator Station, Hi/Low Alarms and Totalizers with Auto/Manual Transfer Station	IND S IND S1 IND S2 IND S3 IND S4 IND S5 IND S6
Auto/Manual Transfer Station with Hi/Low Alarm with Totalizer with Alarm and Totalizer with second Auto/Manual Transfer Station with second Auto/Manual Transfer Station, Hi/Low Alarms and Totalizers with Split Range Outputs	A/M S A/M S1 A/M S2 A/M S3 A/M S4 A/M S5 A/M S6
Single Loop Flow Ratio Controller, 0 to 2 Ratio Range, Square Root Inputs with Hi/Low Alarm with one Totalizer with Hi/Low Alarm and Totalizer with Split Range Outputs with 3-Variable Indicator Station with Auto/Manual Transfer Station	RATIO C RATIO C1 RATIO C2 RATIO C3 RATIO C4 RATIO C5 RATIO C6
Cascade Controller with Hi/Low Primary Alarm with one Totalizer with Hi/Low Alarm and Totalizer	CASCDE C CASCDE C1 CASCDE C2 CASCDE C3
Auto Selector Controller, Low Select with Hi/Low Alarms with Totalizer with Alarms and Totalizer with High Select	A SEL C A SEL C1 A SEL C2 A SEL C3 A SEL C4
Single Loop Controller with Pulse- or Contact-driven Set Point	PULSE SP
Single Loop Controller with Output Freeze from External Contact Input 1	FREEZE
Single Loop Controller with Output Switching to a Preset Value from External Contact input 1	PRESET

^(a) Auxiliary Specification

MODEL CODES

SINGLE STATION MICRO Controller, Housing-Mounted	762CNA
Nominal Supply Voltage and Frequency	
120 V ac, 50/60 Hz	-A
220 V ac, 50/60 Hz	-B
240 V ac, 50/60 Hz	-C
24 V dc	-D
24 V ac, 50/60 Hz	-E
100 V ac, 50/60 Hz	-J
Housing and Signal Connections	
32-Position Terminal Blocks on Rear of Housing	T
Controller Chassis without Housing	W
Optional Selections	
Output Isolation, 4 to 20 mA (Output 1 only)	-1
Platinum RTD Input ^(a) (Input 1 only)	-2
Example: 762CNA-AT-1	

(a) Minimum span with platinum RTD input is 110°C (198°F).

SINGLE STATION MICRO Controller, Shelf-Mounted	762CSA
Signal Connector	
20-Pin Signal Connector, Quick Disconnect ^(a)	-2
30-Pin Signal Connector, Quick Disconnect	-3
Nominal Supply Voltage and Frequency	
120 V ac, 50/60 Hz	A
220 V ac, 50/60 Hz	B
240 V ac, 50/60 Hz	C
24 V dc	D
24 V ac, 50/60 Hz	E
100 V ac, 50/60 Hz	J
Optional Selections	
Output Isolation, 4 to 20 mA (Output 1 only)	-1
Platinum RTD Input ^(b) (Input 1 only)	-2
Example: 762CSA-3E-12	

(a) The following controller features cannot be accessed when the 20-pin signal connector is used: Analog Input 3, frequency inputs, pulse inputs, RTD input option, 28 V dc field power to one transmitter (power can be supplied to one transmitter only).

(b) Minimum span with platinum RTD input is 110°C (198°F).

DIMENSIONS-NOMINAL
762CNA Controller - Housing-Mounted

mm
in

FOR PANEL CUTOUT DIMENSIONS, SEE NEXT PAGE.

FOR DIVISION 2 INSTRUMENTS, SEE BOTTOM OF PAGE.

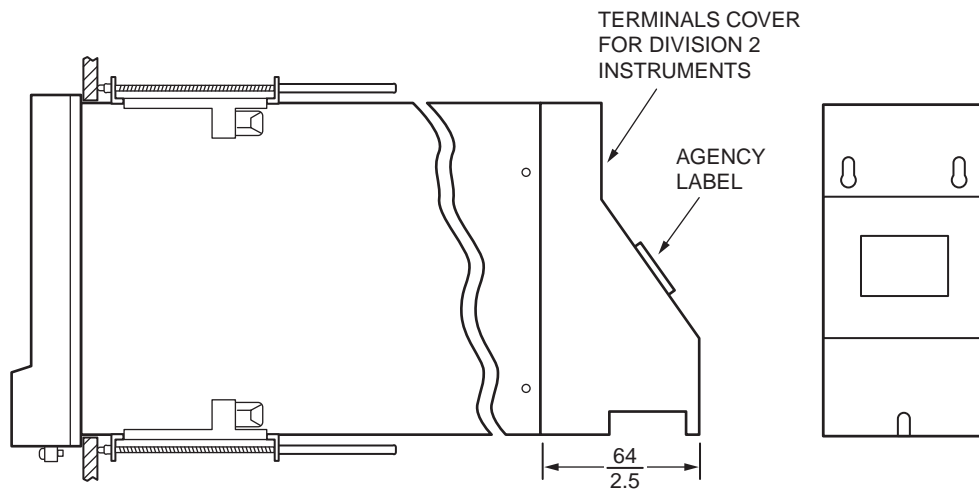
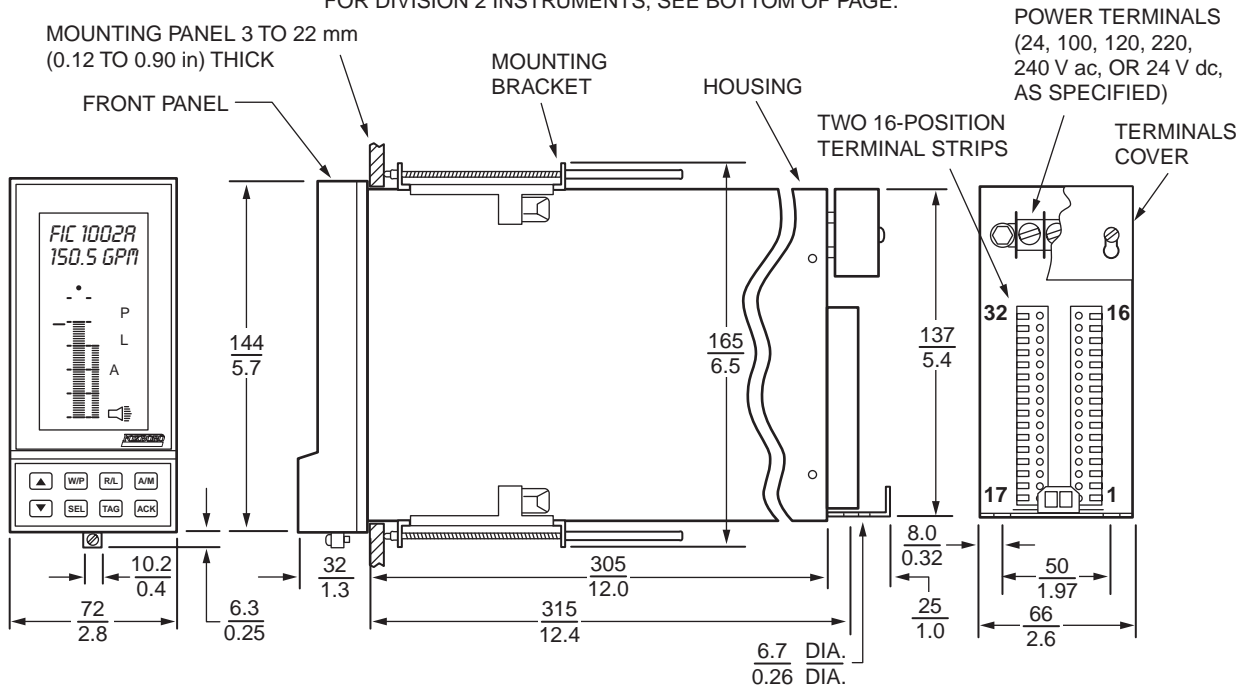

DIMENSIONS-NOMINAL (Cont.)
762CNA Controller - Housing-Mounted (Cont.)

mm
in

PANEL CUTOUT DIMENSIONS

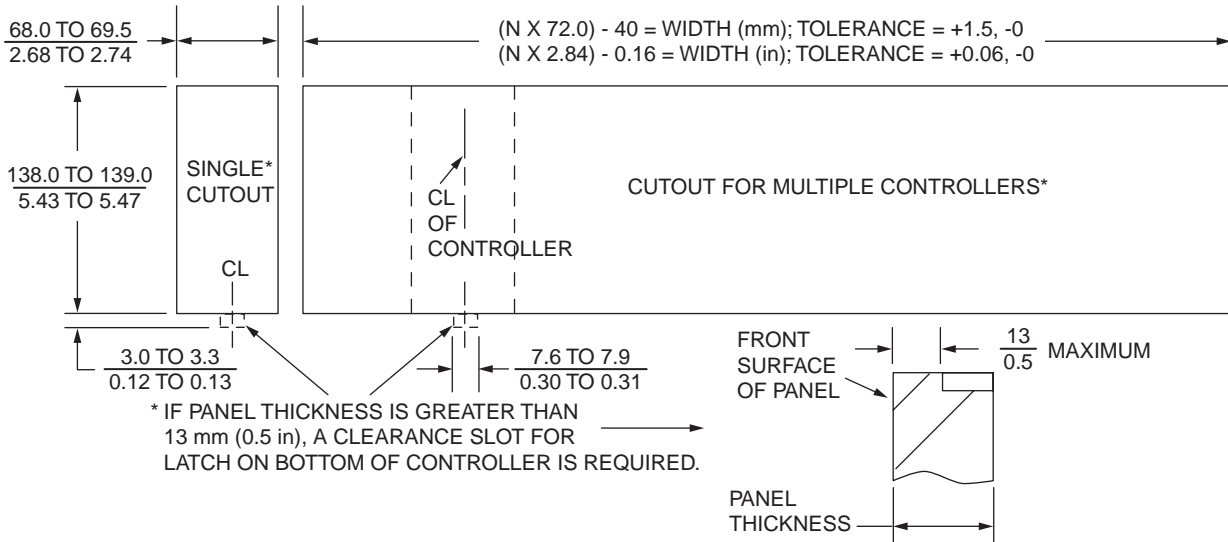

* IF PANEL HAS MORE THAN ONE CUTOUT, ALLOW 45 mm (1.78 in) VERTICAL DISTANCE BETWEEN CUTOUTS AS SHOWN BELOW. THIS PROVIDES 36 mm (1.4 in) SPACING BETWEEN CONTROLLERS.

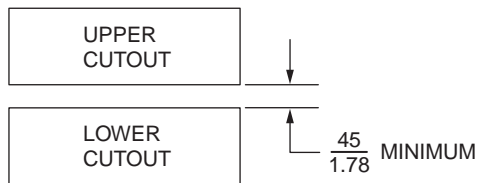

DIMENSIONS-NOMINAL (Cont.)

762CNA Controller - Shelf-Mounted

For dimensions of shelves used with 762CSA Controllers,
refer to the applicable Dimensional Print listed in the table below.

SHELF MODEL	DIMENSIONAL PRINT
EH	DP 018-510
101	DP 017-441
102	DP 017-410
202S	DP 202-100

ORDERING INSTRUCTIONS

1. Model Number
2. Electrical Classification
3. Optional Features
4. Accessories
5. Optional Factory Pre-Configuration
6. User Tag Data

PATENT NOTICE

This product and its components are protected by one or more of the following U.S. Patents, and other patents pending:

4, 616, 332; 4, 658, 348; 4, 704, 676; RE 33267; and corresponding foreign patents.

The Foxboro Company
33 Commercial Street
Foxboro, MA 02035-2099
United States of America
<http://www.foxboro.com>
Inside U.S.: 1-888-FOXBORO
(1-888-369-2676)
Outside U.S.: Contact your local
Foxboro representative.
Facsimile (508) 549-4492

Foxboro, SINGLE STATION MICRO, and EXACT are registered trademarks of The Foxboro Company.
Siebe is a registered trademark of Siebe, plc.

Copyright 1994-1996 by The Foxboro Company
All rights reserved